

IN-007

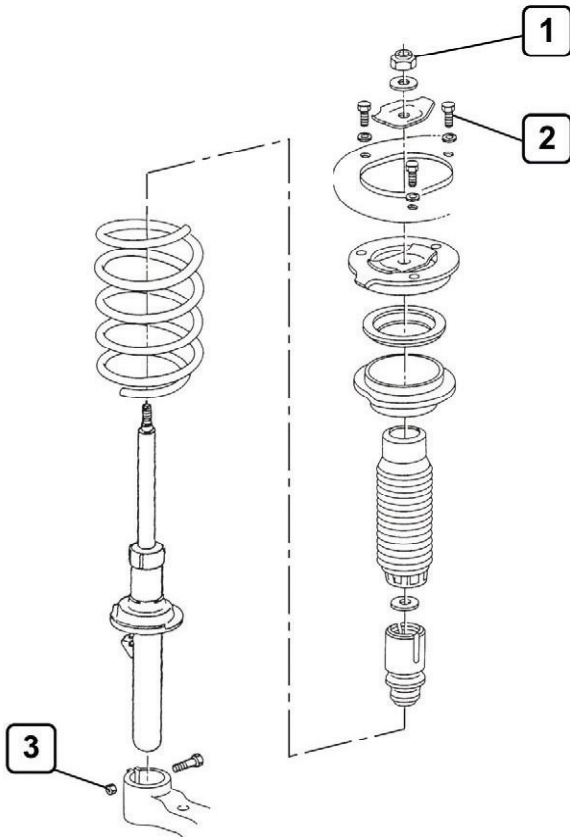

- 1** 50 Nm
- 2** 20 Nm
- 3** 50 Nm
- 4** 40 Nm



 O.E
 KYB

