

Installation Manual

AS-3238
ARNOTT
FRONT AIR STRUT
MERCEDES-BENZ E-CLASS (W/4-MATIC)(W212)
MERCEDES-BENZ CLS (W/4-MATIC)(W218)



Congratulations on your purchase of an Arnott® air suspension product. We at Arnott Incorporated are proud to offer a high quality product at the industry's most competitive pricing. Thank you for your confidence in us and our product.

Proper installation is essential to experience and appreciate the benefits of this system. Please take a moment to review these installation instructions before you begin to install these components on your vehicle. The removal and installation of air suspension products should only be performed by a fully qualified, ASE Certified, professional.

It is equally important to be aware of all necessary safety measures while installing your new Air Suspension System. This includes proper lifting and immobilizing of the vehicle and isolation of any stored energy to prevent personal injury or property damage.

"Engineered to Ride, Built to Last®"



WARNING: *The air suspension system is under pressure (up to 10 bar, or 150 lbf/in). Verify pressure has been relieved and disconnect power to the air suspension system prior to disassembly. Do not allow dirt or grease to enter the system. Always wear standard hand, ear, and eye protection when servicing the air suspension system.*

Arnott® is committed to the quality of its products. If you have a question or problem with any Arnott product, please contact Arnott by calling 800-251-8993 during normal business hours or email techassistance@arnottinc.com. (In the EU please call +31 (0)73 7850 580 or email info@arnotteurope.com)

GENERAL INFORMATION:

Reading this manual signifies your agreement to the terms of the general release, waiver of liability, and hold harmless agreement, the full text of which is available at www.arnottinc.com.

- Not to be stored below 5°F (-15°C) or above 122°F (50°C).
- Avoid damage to air lines and cables.
- Removal and installation is only to be performed by fully qualified personnel.
- Use car manufacturer's diagnostic software.

CAUTION: *Damage to the vehicle and air suspension system can be incurred if work is carried out in a manner other than specified in the instructions or in a different sequence.*



To avoid the possibility of short circuits while working with electric components consult your owner's manual on how to disconnect your battery.



Consult your vehicle owner's manual, service manual, or car dealer for the correct jacking points on your vehicle and for additional care, safety and maintenance instructions. Under no circumstances should any work be completed underneath the vehicle if it is not adequately supported, as serious injuries and death can occur.

AIR STRUT REMOVAL

1. SET STEERING TO STRAIGHT AHEAD.
2. RAISE VEHICLE.

NOTE: REFER TO THE SERVICE MANUAL FOR PROPER DEFLATION PROCEDURE.

3. REMOVE APPLICABLE FRONT WHEEL. (FIGURE 1)



FIGURE 1

4. REMOVE THE COVER FROM THE TOP OF AIR STRUT TO GAIN ACCESS TO THE AIR LINE. (FIGURE 2 - #10)

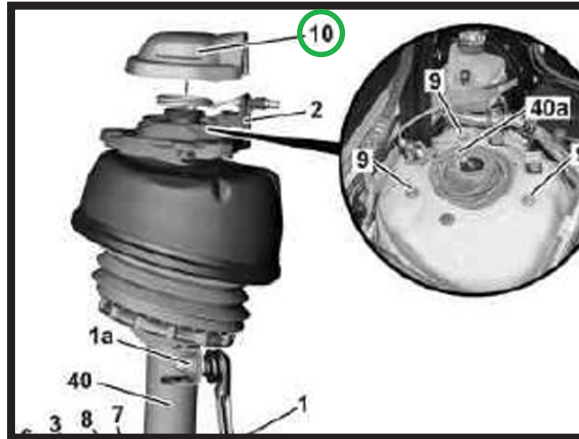

FIGURE 2 - #10

5. REMOVE THE AIR LINE TO DEFLATE THE AIR STRUT. REMOVE THE AIR LINE FITTING FROM THE AIR HOSE AND DISCARD. (FIGURE 3)



PRIOR TO INSERTING THE EXISTING AIR LINE INTO THE NEW AIR FITTING YOU WILL NEED TO REMOVE THE OLD ORIGINAL EQUIPMENT AIR LINE FITTING.

NOTE:

SCRATCHES AND/OR DEEP CUTS IN THE AIR LINE CAN RESULT IN POSSIBLE LEAKS. INSPECT THE AIR LINE BEFORE INSERTION. AIR LINE NEEDS TO BE REPLACED IF DAMAGED.

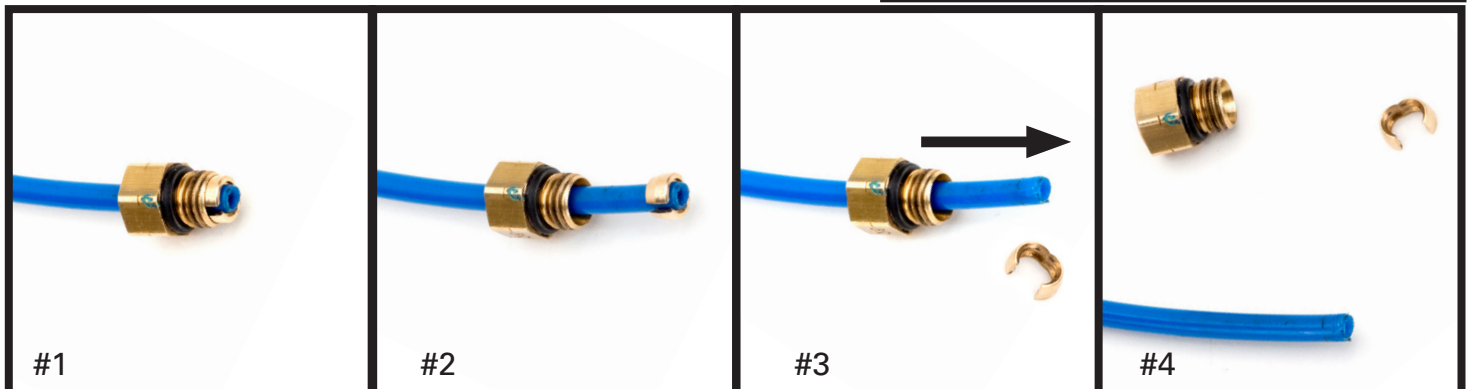

OE AIR LINE FITTING.

SLIDE THE THREADED PORTION UP THE LINE AND SPREAD THE COLLET OPEN TO REMOVE.

SLIDE THE AIR FITTING OFF OF THE AIR LINE.

AIR LINE IS READY FOR INSTALLATION.

FIGURE 3

6. DISCONNECT THE ADS PLUG FROM THE BOTTOM OF THE SHOCK. (FIGURE 4 - #Y51, #Y52)

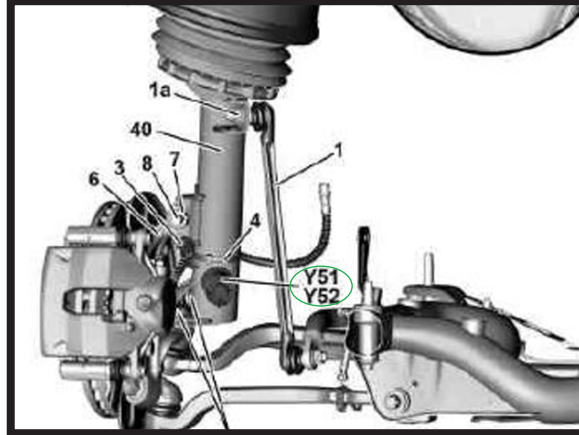

FIGURE 3 - #Y51, #Y52

7. CUT THE CABLE TIE FROM THE SHOCK AND UNCLIP THE LINE BRACKET. (FIGURE 5 - #12)

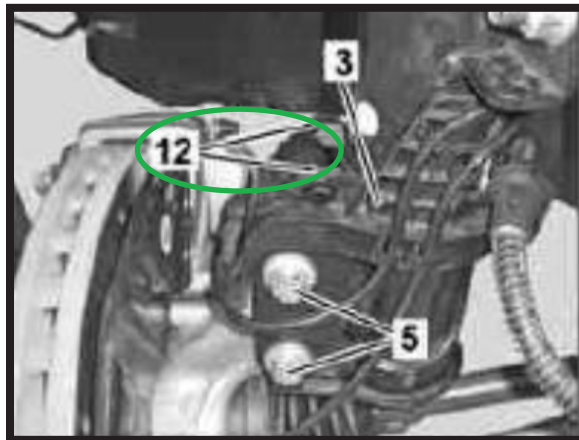

FIGURE 5 - #12

8. REMOVE THE SWAY BAR END-LINK. (FIGURE 6 - #1a)

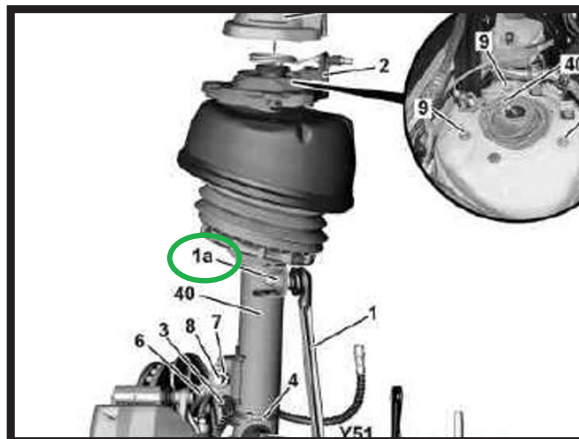

FIGURE 6 - #1a

9. LOOSEN AND REMOVE THE LOWER MOUNTING BOLTS. SUPPORT THE SPINDLE TO PREVENT DAMAGE TO THE AXLE AND LINES (FIGURES 7, 8 - #5, #11)

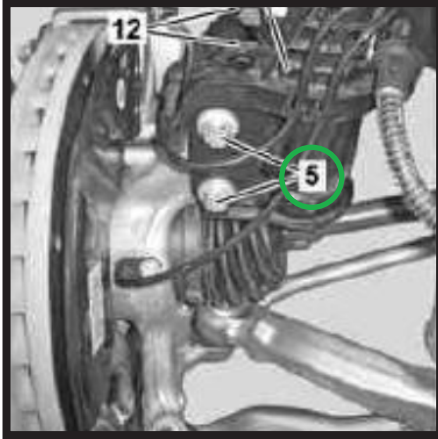

FIGURE 7 - #5

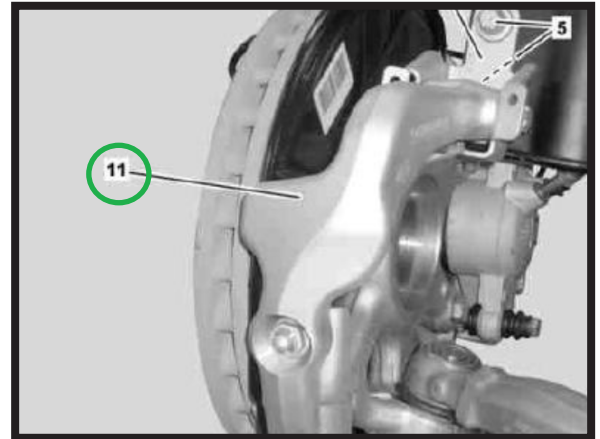

FIGURE 8 - #11

10. LOOSEN AND REMOVE THE UPPER MOUNTING BOLTS FROM THE STRUT TOWER. (FIGURE 9 - #9)

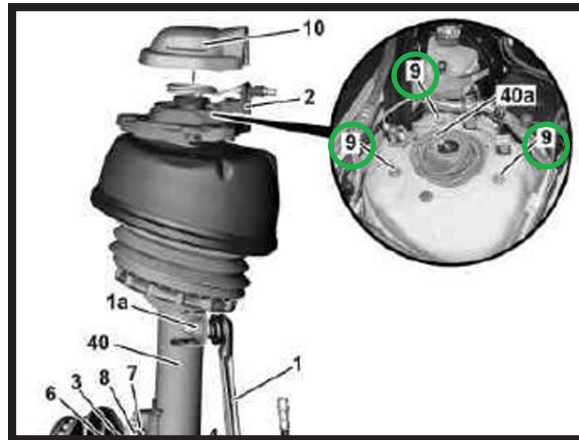

FIGURE 9 - #9

11. CAREFULLY REMOVE THE AIR STRUT FROM THE VEHICLE.

AIR SHOCK INSTALLATION

1. INSTALLATION IS IN REVERSE ORDER OF REMOVAL.