



**Einbauanleitung Elektrosatz  
Anhängervorrichtung mit 12-N Steckdose  
lt. DIN/ISO Norm 1724**

**Instructions de montage du faisceau  
électrique pour crochet d'attelage  
conforme à la norme  
DIN/ISO 1724 prise 12-N**

**Fitting instructions electric wiringkit  
towbar with 12-N socket up to  
DIN/ISO norm 1724**

**Montage-handleiding elektrokabelset voor  
trekhaak met 12-N contactdoos  
vlg. DIN/ISO norm 1724**

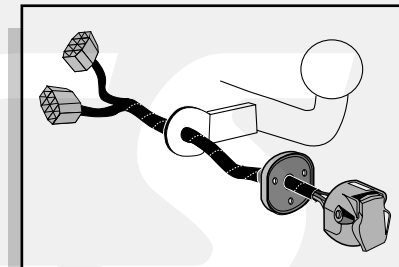

OPEL VECTRA SEDAN /HB 1996- COMBI 1997- MODEL 1999  
With prepared connector

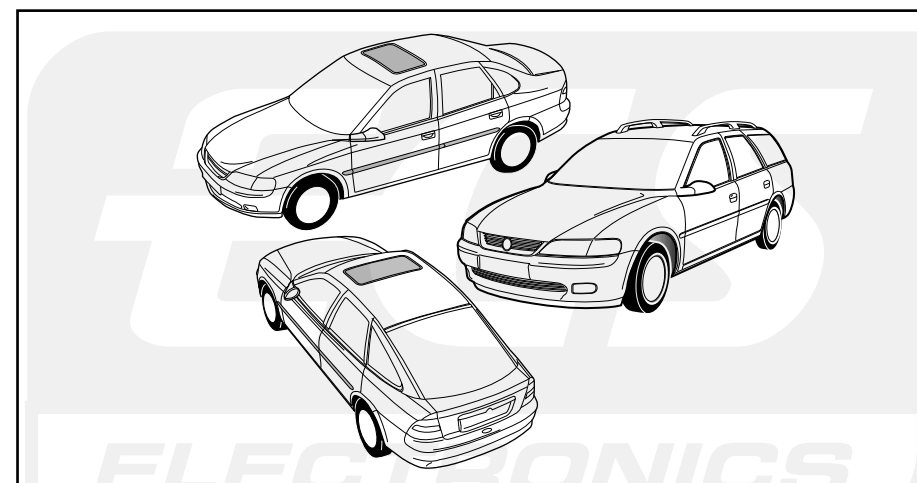

Bestel Nr.: OPE-037-B



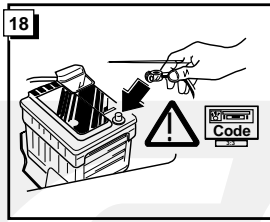
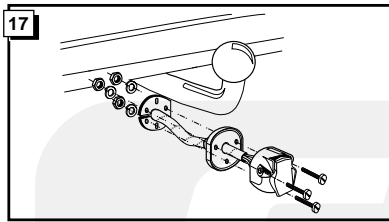

19

**CONTROLEER FUNCTIES !**  
**CHECK FUNCTIONS !**  
**FUNKTIONEN KONTROLIEREN !**  
**CONTRÔLER LES FONCTIONS !**

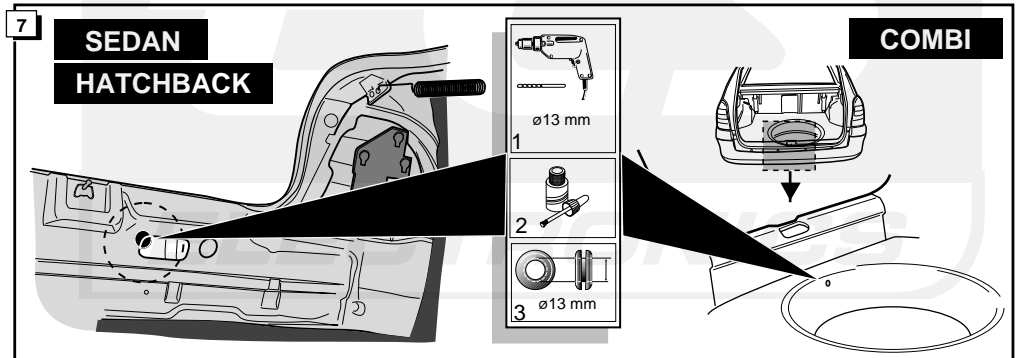
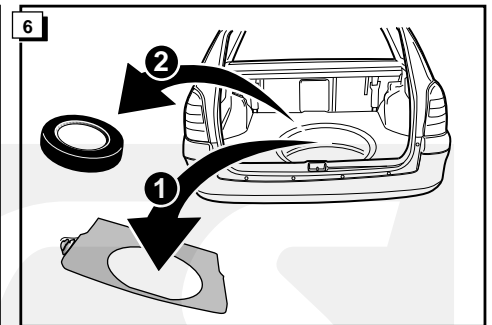
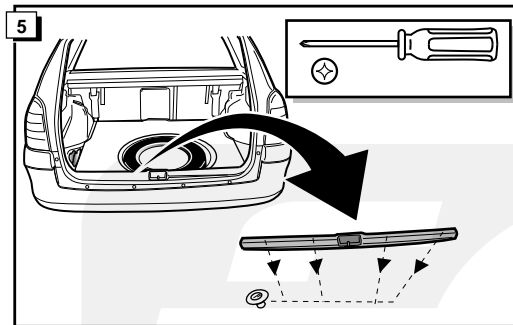
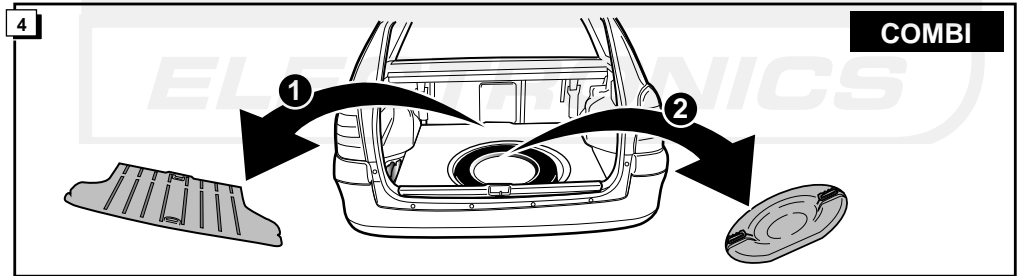
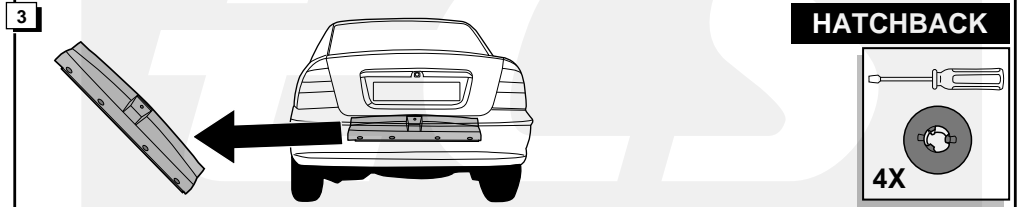
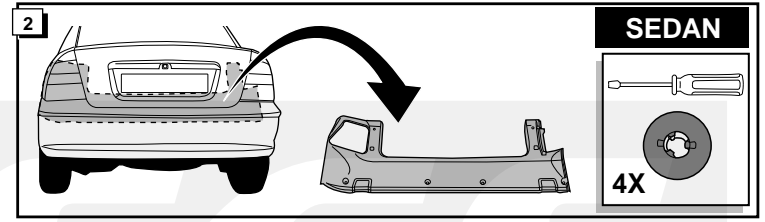
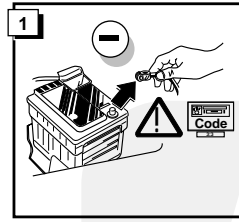
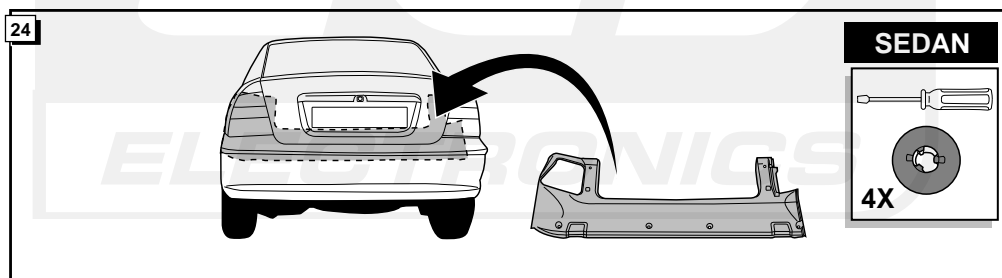
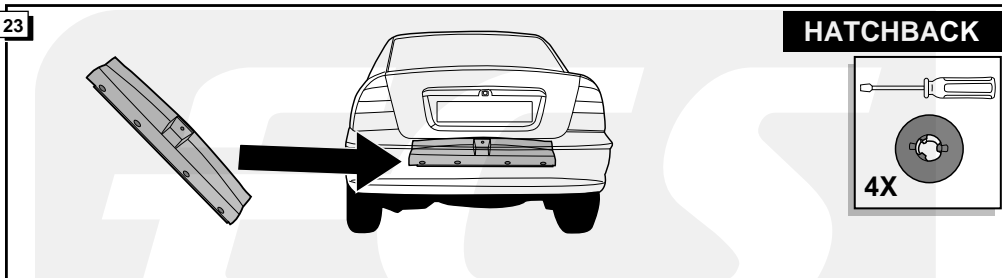
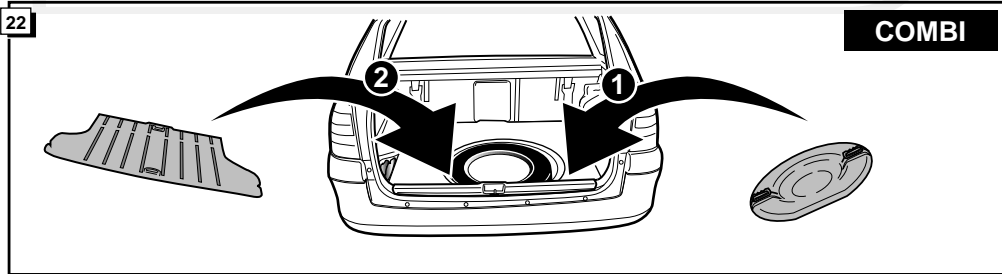
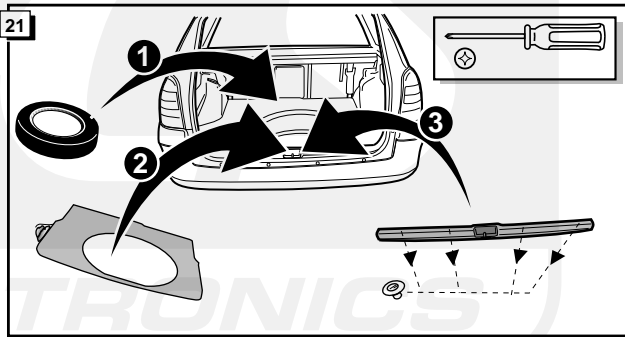
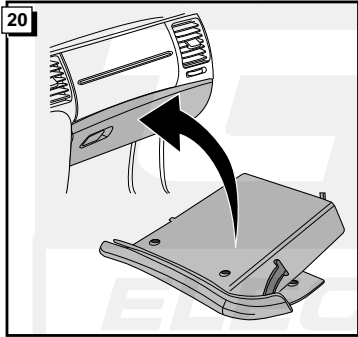

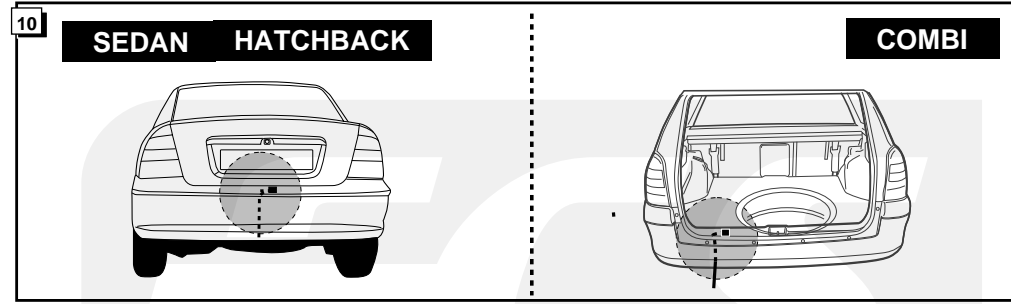
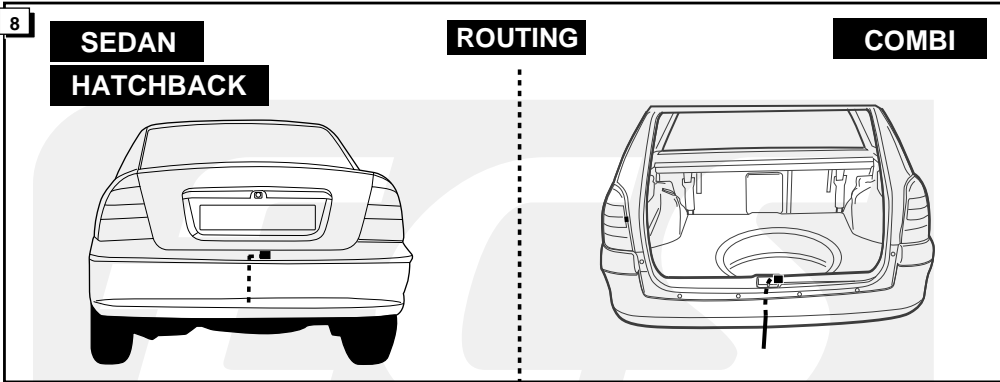

**9**

	NL	UK	D	F
1 = L	GEEL	YELLOW	GELB	JAUNE
2 = 54-G	BLAUW	BLUE	BLAU	BLEU
3 = 31	WIT	WHITE	WEIß	BLANC
4 = R	GROEN	GREEN	GRÜN	VERT
5 = 58-R	BRUIN	BROWN	BRAUN	MARRON
6 = 54	ROOD	RED	ROT	ROUGE
7 = 58-L	ZWART	BLACK	SCHWARZ	NOIR
8 = 58-b	GRIJS	GREY	GRAU	GRIS

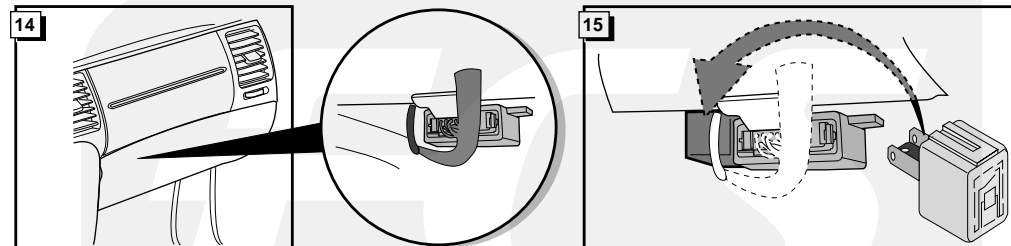
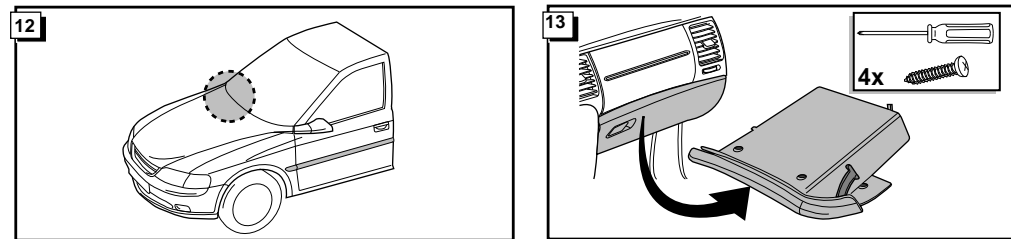
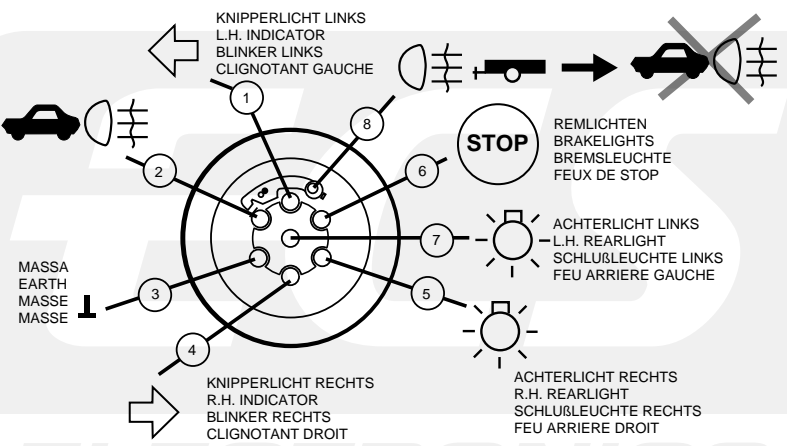
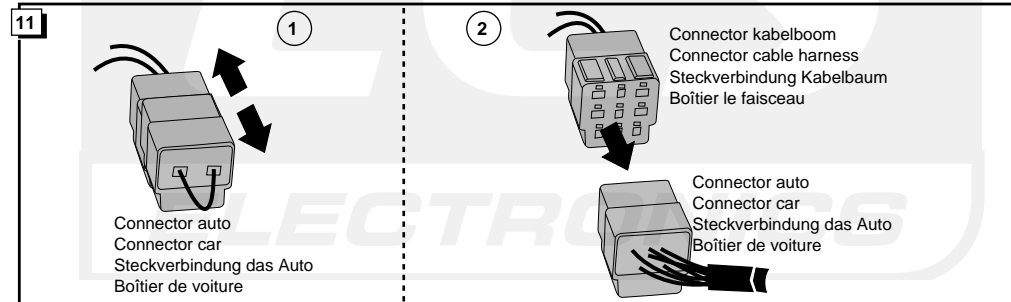

**16** Indien de remlichten van de aanhanger niet functioneren, monteer het meegeleverde grijze dummy-relais. Wanneer het voertuig is uitgerust met c.c. dan kunt u ook het originele Opel relais (nr. 90460698) monteren, die dan het functioneren van de remlichten van de aanhanger controleert.

When the brakelights do not function, then fit the supplied grey dummy-relay. If the vehicle is equipped with c.c. then it is possible to fit the original Opel relay (nr. 90460698), which controls the functions of the trailers brakelights.

Wenn die Bremsleuchten nicht funktionieren, montieren Sie das mitgelieferte graue Dummy-Relais. Wenn der Fahrzeug mit Check-control ausgestattet ist, ist es möglich das originale OPEL Relais (Nr. 90460698) zu gebrauchen. Das Relais kontrolliert die Funktionen der Anhängersbremsleuchten

Si les feux de stop ne fonctionnent pas, montez alors le relais-dummy gris livré. Si le véhicule est équipé d'un système de contrôle, il est alors possible de monter le relais OPEL d'origine (no. 90460698) qui controle les fonctions des feux de la remorque/caravane.